



CAR0315 Series

裕智电感



Outline: 产品概要

- Use ferrite core, high frequency.
铁氧体磁芯，工作频率高。
- Low DC resistance, high saturation current.
低直流电阻，高饱和电流。
- Lead free product, RoHS compliant.
无铅产品，符合 RoHS 指令。
- Widely used in switching power supply, power amplifier, output antenna, filter, displayer, UPS, and etc.
广泛应用于开关电源，功率放大器，输出天线，滤波器，显示器，不间断电源等。
- Operating temperature : $-40^{\circ}\text{C} \sim +125^{\circ}\text{C}$
(Including coil's temperature rise)
工作温度: $-40^{\circ}\text{C} \sim +125^{\circ}\text{C}$ (包含线圈发热)

1 Appearance and dimensions (mm) 外形尺寸

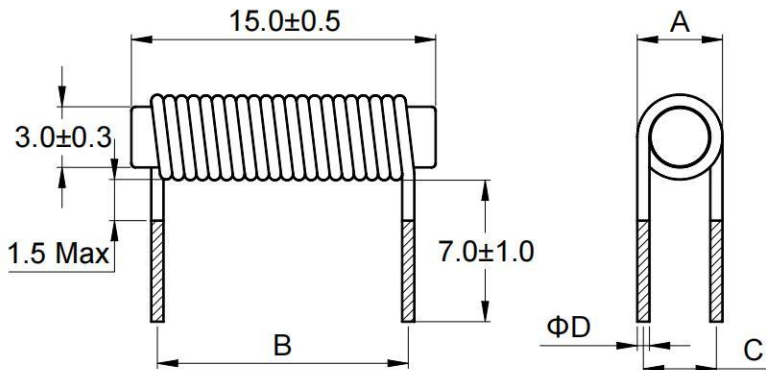

2 Schematic 原理图

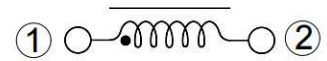

3 Reference hole pattern (mm) 参考焊孔尺寸

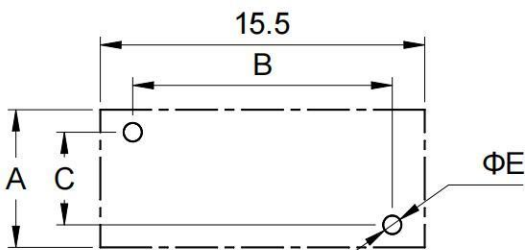

Part No. 型号	A	B	C	D	E
	Max	± 1.0	± 0.5	± 0.15	Ref.
2R2	5.20	9.00	3.70	0.70	1.10
3R3	4.90	10.5	3.60	0.65	1.10
4R7	4.80	13.0	3.60	0.60	1.00
6R8	4.60	11.5	3.50	0.45	0.90
100	4.30	13.0	3.40	0.40	0.80



4 Electrical characteristics

电气特性

Part No. 型号	Inductance (μH) 电感值 ※1 $\pm 20\%$	D.C.R. ($\text{m}\Omega$) 直流电阻		Saturation current (A) 饱和电流 ※2 Typical	Temperature rise current (A) 温升电流 ※3 Typical
		Typical	Max		
RAR0315-2R2M	2.20	7.46	9.70	6.50	9.30
RAR0315-3R3M	3.30	10.1	13.2	5.50	8.00
RAR0315-4R7M	4.70	14.8	19.2	4.00	6.60
RAR0315-6R8M	6.80	28.6	37.1	3.50	4.70
RAR0315-100M	10.0	42.9	55.8	3.20	3.90

■ All data is tested based on 25°C ambient temperature.

所有数据基于环境温度 25°C 条件下测试。

※1 Inductance measure condition at 1kHz, 0.25V.

电感测试条件为 1kHz, 0.25V。

※2 Saturation current: the actual value of DC current when the inductance decrease 20% of its initial value.

饱和电流: 电感值下降其初始值的 20% 时所加载的实际直流电流值。

※3 Temperature rise current: the actual value of DC current when the temperature rise is $\Delta T 40^\circ\text{C}$ ($T_a = 25^\circ\text{C}$).

温升电流: 使产品温度上升到 $\Delta T 40^\circ\text{C}$ 时所加载的实际直流电流值 ($T_a = 25^\circ\text{C}$)。

※ Special remind: Circuit design, component placement, PWB size and thickness, cooling system and etc.

all will affect the product temperature. Please verify the product temperature in the final application.

特别提醒: 线路设计, 组件布局, 印刷电路板(PWB)尺寸及厚度, 散热系统等均会影响产品温度。

请务必在最终应用时, 验证产品发热状况。



5 Saturation current VS temperature rise current curve

饱和电流 VS 温升电流曲线

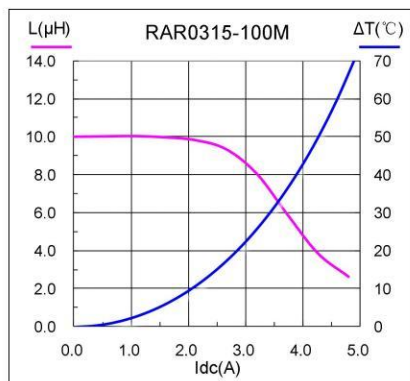
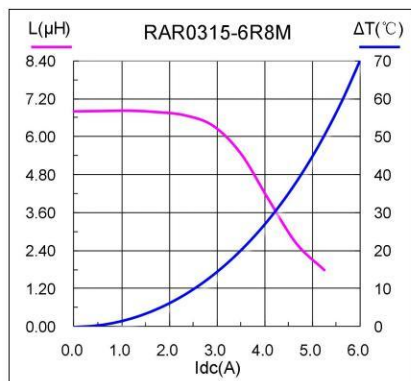
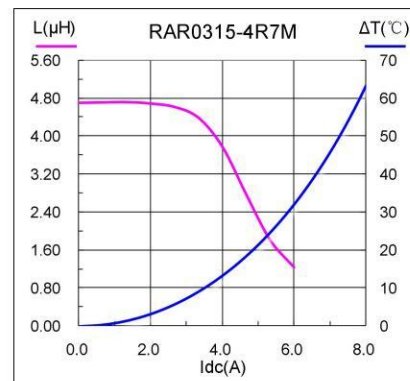
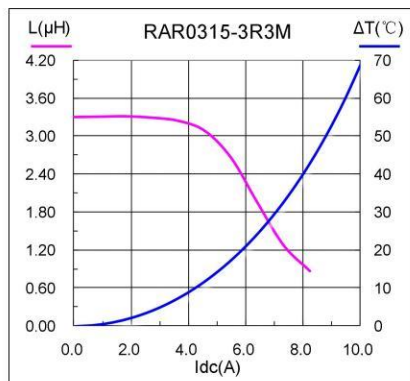
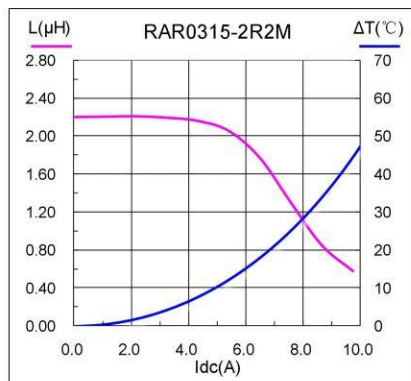



6 Packing specification

包装规格

6.1 Plastic tray dimensions (mm)

吸塑盘尺寸

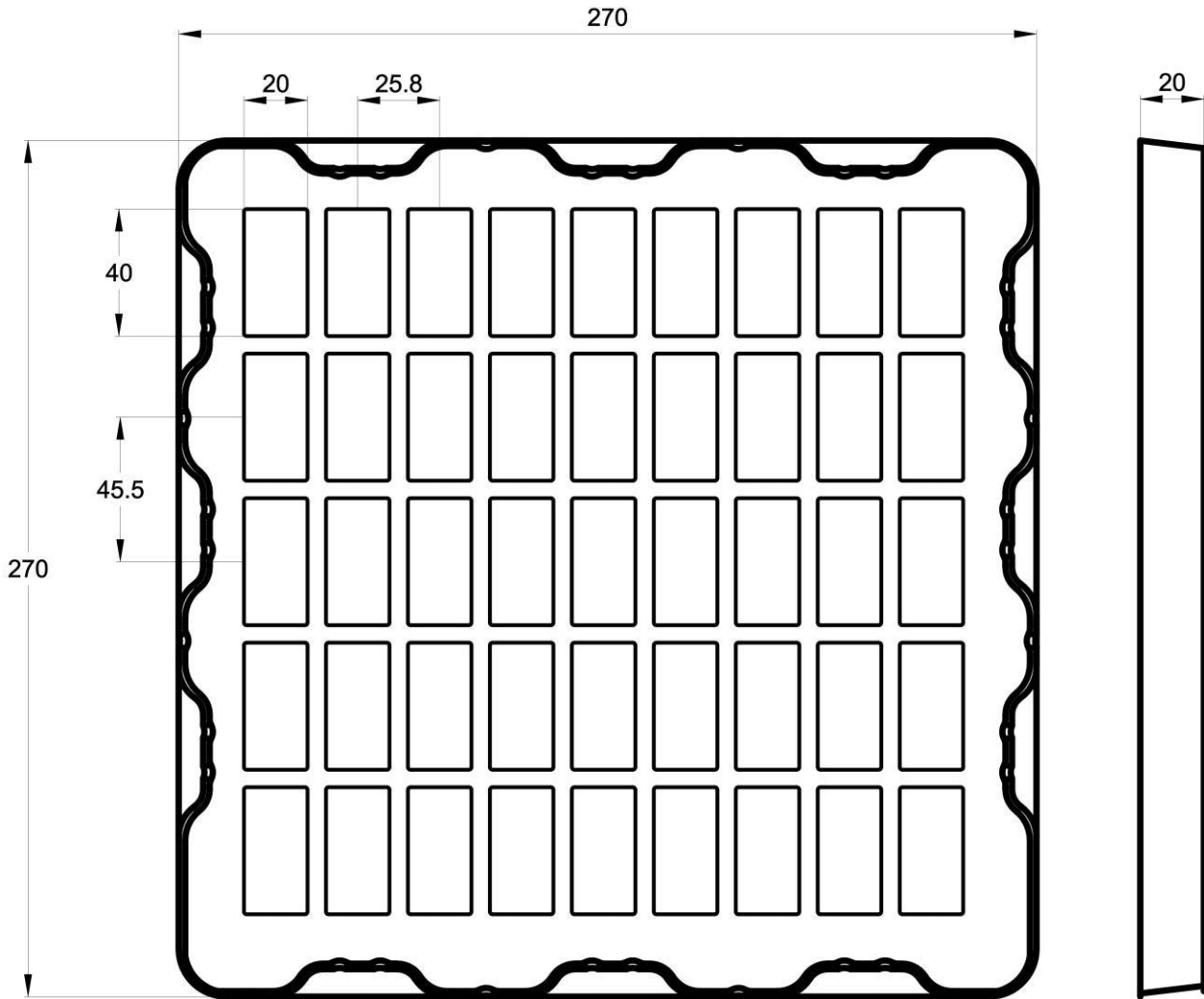



7 Packing specification

包装规格

7.1 Packing

包装

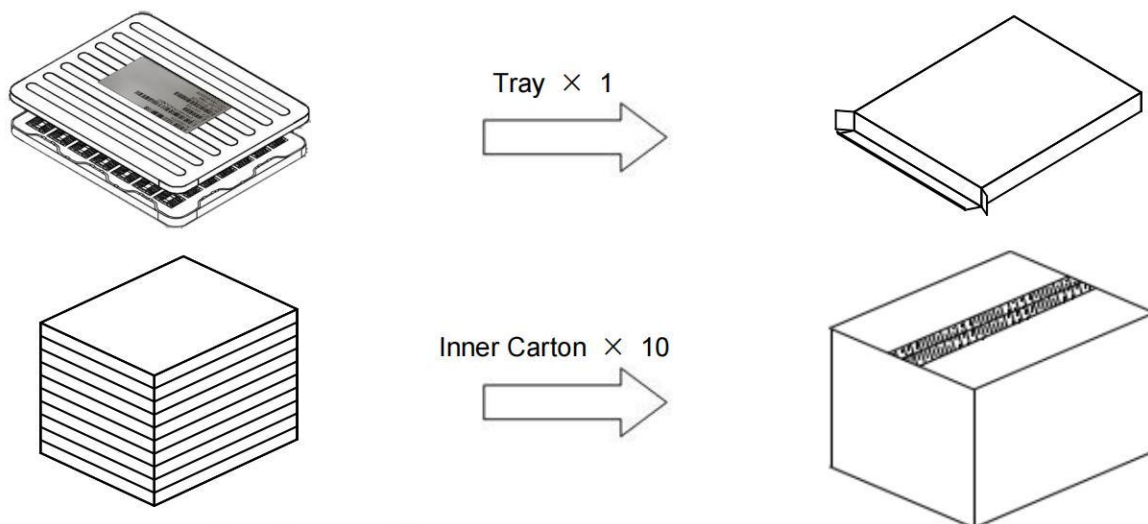

7.2 Carton dimensions and packing quantity

包装箱尺寸和包装数量

■ Inner Carton: 265×205×25mm
内包装盒

■ Out Carton : 275×232×261mm
外包装箱

Product Series 产品系列	Quantity / tray 数量 / 盘	Inner Carton Quantity 内盒 包装数量	Out Carton Quantity 外箱 包装总数量
RAR0315	450pcs	(450×1) = 450pcs	(450×10) = 4500pcs

7.3 Label making

标签标识

The following items will be marked on the tray of product label and shipping label.
以下项目将明确标识于产品吸塑盘标签以及运输标签上。

Production Label 产品标签

- Part No.
产品型号
- Electrical Information
产品电性信息
- Quantity
数量
- Packing No.
包装流水号

Shipping Label 运输标签

- Customer Name
客户名称
- Customer Part No.
客户型号
- Supplier Part No.
供应商型号
- Supplier Name
供应商名称
- Country of origin
产品产地